

# OWNERS MANUAL

## The 3.0



# OWNERS MANUAL

## The 3.0



# TABLE OF CONTENTS

Important Safety Information	4
Machine Assembly	5
Exhaust Assembly	6
Cover Assembly	7
Triple-Bag Kief Collection System	8
Leaf Collector Assembly	9
Medical Grade Hopper Assembly	10
Cloth Hopper Assembly	11
Blade Removal	12
Cleaning the 3.0	12
Leaf Collector Cleaning	13
Machine Maintenance	14
Quantanium Coated Non-Stick Tumbler	15
Warranty Information	16
Frequently Asked Questions	17
Additional Assistance	18
3.0 and Leaf Collector Specifications	19
Trimming Dry? Here Are Some Important Tips	20
Trim Both Wet and Dry	21
Troubleshooting	22-23

# IMPORTANT SAFETY INFORMATION



## IMPORTANT

This document refers to the CenturionPro Solutions 3.0 automated trimming system.

The 3.0 is a high-speed trimming system, requiring that specific safety precautions are practiced during operation to reduce the risk of personal injury. Improper use of The 3.0, or any Centurion Pro trimming machine, may cause serious or fatal injury. Please ensure you read the operations manual and warning notes before using the 3.0.

Do not lend out or rent your 3.0 without this operating manual. A first time user should obtain proper instruction prior to use.

## GENERAL

- Do not move, disassemble, clean or inspect the trimmer while the power is still connected to the machine.
- Replacement parts are specific to The 3.0 and must be purchased from an authorized dealer only. Substituting factory parts with non-approved third-party replacements may result in damage to the machine or bodily harm.
- Keep all individuals a safe distance from the work area. Do not operate the machine around children.
- Do not remove safety labels. Replace any and all labels if they become damaged or obscured.

## CONNECTION

- As with home appliances, The 3.0 must be used in connection with a properly grounded receptacle.
- Never plug in or power up your trimming machine if the protective shrouds are removed.
- Do not use extension cords over 8m (25ft) in length to power the 3.0.

## OPERATION

- The initial set up will show assembly instructions to unpack and set-up your machine.
- Your bed bar blade has been factory set to cut perfectly. Please do not adjust your blade until it is time to clean the machine. Also, please watch the video tutorial located on our website on how to adjust your blade before attempting.
- Safety glasses should be worn at all times while operating The 3.0.
- Do not operate any trimming machine while tired or under the influence of medication, drugs or alcohol.
- Do not put anything other than plant material into the tumbler. Doing so may cause damage to the tumbler, the machine or result in bodily harm.
- Operate the trimmer in a well ventilated area in order to prevent overheating.

## MAINTENANCE

- Never leave The 3.0 system running unattended.
- Never conduct maintenance or cleaning while the machine is plugged in.
- Do not modify or adapt any part of the trimmer or its accessories. Doing so may cause irreversible damage to the machine or result in bodily harm.



# MACHINE ASSEMBLY

**110V** North America  
**220V** Australia EU

Machine Only!

Step 3  
**INSTALL COVER**

Step 2  
**INSTALL UPPER FRAME X 3**

Step 1  
**PLACE TUMBLERS IN GROOVES X 3**

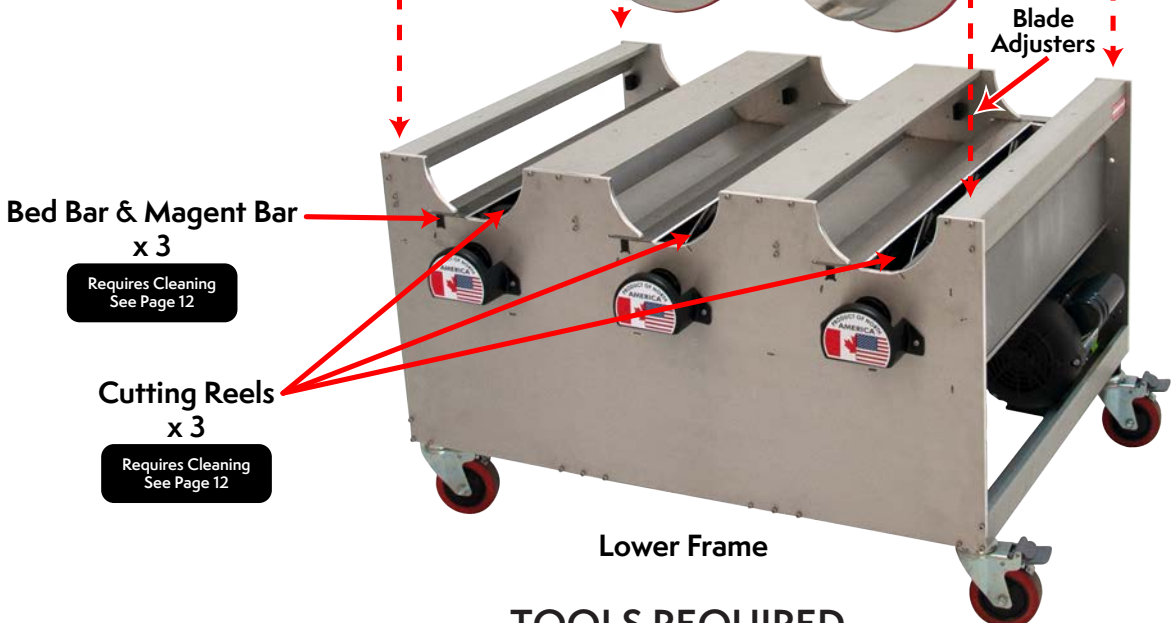
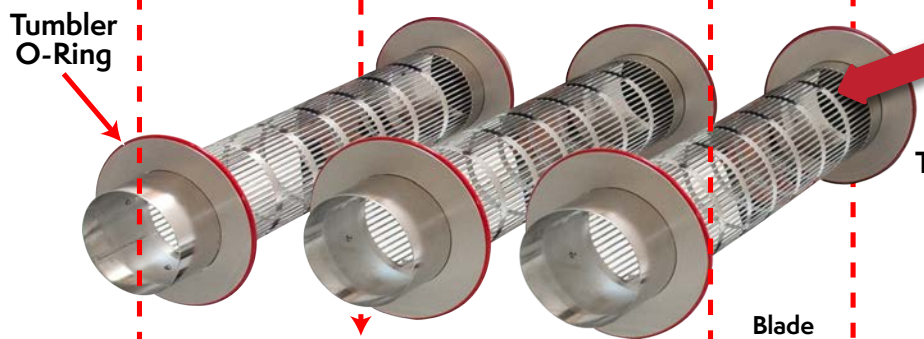
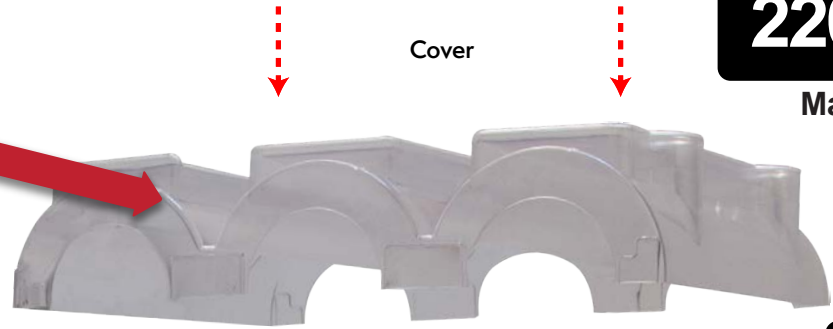
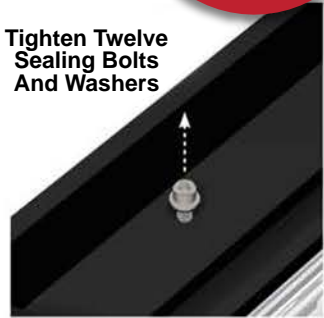

## TOOLS REQUIRED

- |          |                       |          |                       |
|----------|-----------------------|----------|-----------------------|
| 1x #2    | Phillips Screwdriver  | 1x 1/8"  | T-Handle Allen Wrench |
| 1x 3/32" | T-Handle Allen Wrench | 1x 3/16" | T-Handle Allen Wrench |
| 1x 5/32" | T-Handle Allen Wrench | 1x 3/8"  | Wrench                |

# EXHAUST ASSEMBLY



# COVER ASSEMBLY



It is UNSAFE to operate the 3.0 Trimmer without COVERS!

Step 1  
ATTACH THE  
BEARING COVERS  
TO THE  
3.0

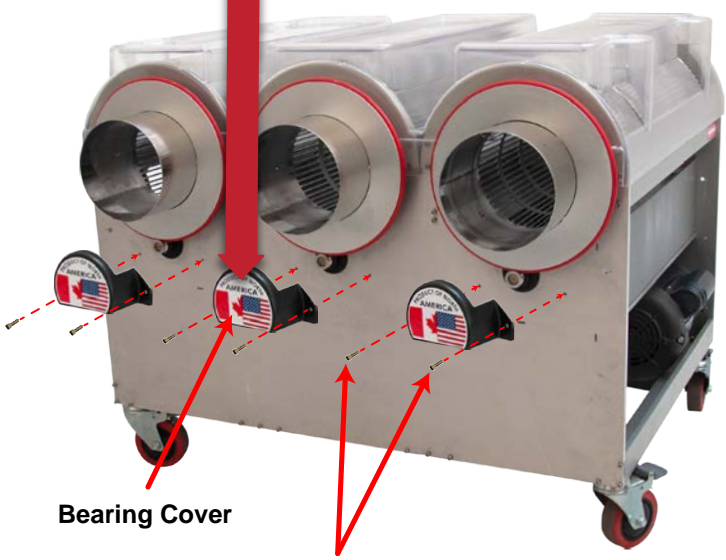

Bearing Cover

2 x Washers  
2 x Bolts

Step 2  
ATTACH THE BELT  
COVER TO THE  
3.0

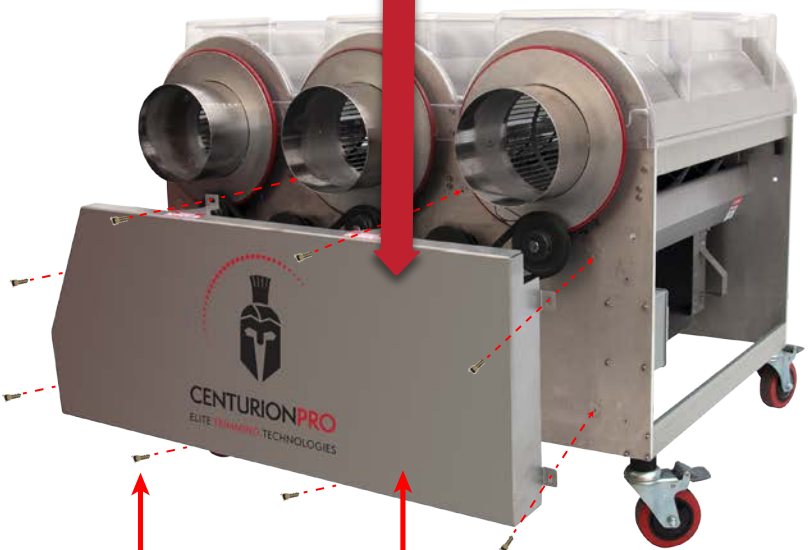

9 x Washers  
9 x Bolts

Belt Cover

# TRIPLE-BAG KIEF COLLECTION SYSTEM

Kief is becoming wildly popular due to the rise of extractions. Unfortunately, machines that require sprays can contaminate and destroy your Kief, therefore making it virtually useless.

Thankfully, CenturionPro offers an optional non-stick Quantanium coating on the tumblers. This means no spray is needed so your Kief remains 100% pure and usable. To further benefit growers, we developed a new triple-bag filtration system. This system will assist with Kief collection, separating it from your trim. This allows you to safely and easily collect the precious trichomes for further processing and profits.

With your machine, you will see that you have a black mesh bag, a white nylon bag, and an outer cloth bag. The black bag goes inside the white nylon bag, which then goes inside the white cloth bag.

## HOW IT WORKS

STEP **1**

The green leafy trim will collect in the new inner black bag.

STEP **2**

Only the Kief makes it through the black bag and collects in the outer mesh bag.

STEP **3**

Outer cloth bag catches any Kief that may pass through the micron white bag.

STEP **4**

Turn off the machine and remove the inner bag and then extract Kief. ENJOY!

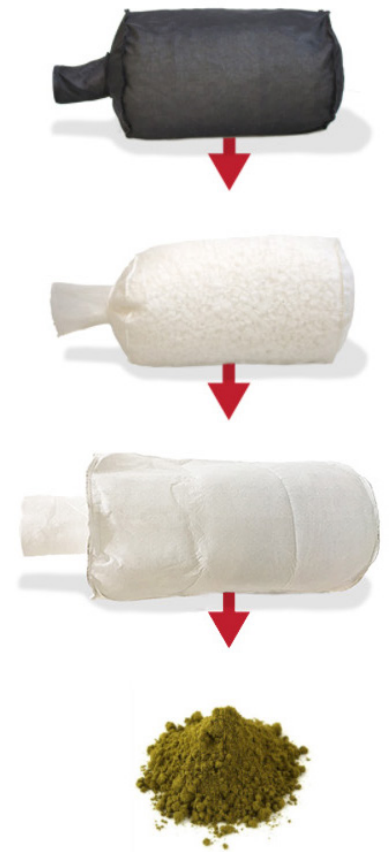

The bags are easy to wash with a pressure washer using cold water. The bags can also be put through the washing machine, but it is recommended to be run through on a cold delicate cycle only.





# LEAF COLLECTOR ASSEMBLY

**Step 1  
ATTACH BAG  
SYSTEM TO LEAF  
COLLECTOR**

Disregard HOLE  
on top of diverter

**⚠ 220V**

**Operate at 220V only!  
Leaf Collector Only**



**Step 2  
ATTACH EXHAUST  
TO LEAF  
COLLECTOR  
(NO BOLTS NEEDED)**

**Kief Collection System  
Requires Cleaning  
(See page 13)**

Please disregard hole on  
top of diverter, the suction  
will hold the diverter in  
place and no screw is  
needed to secure.



**Leaf Collector  
Requires Cleaning  
(See page 11)**

(Requires Cleaning See Page 12)



# MEDICAL GRADE HOPPER ASSEMBLY

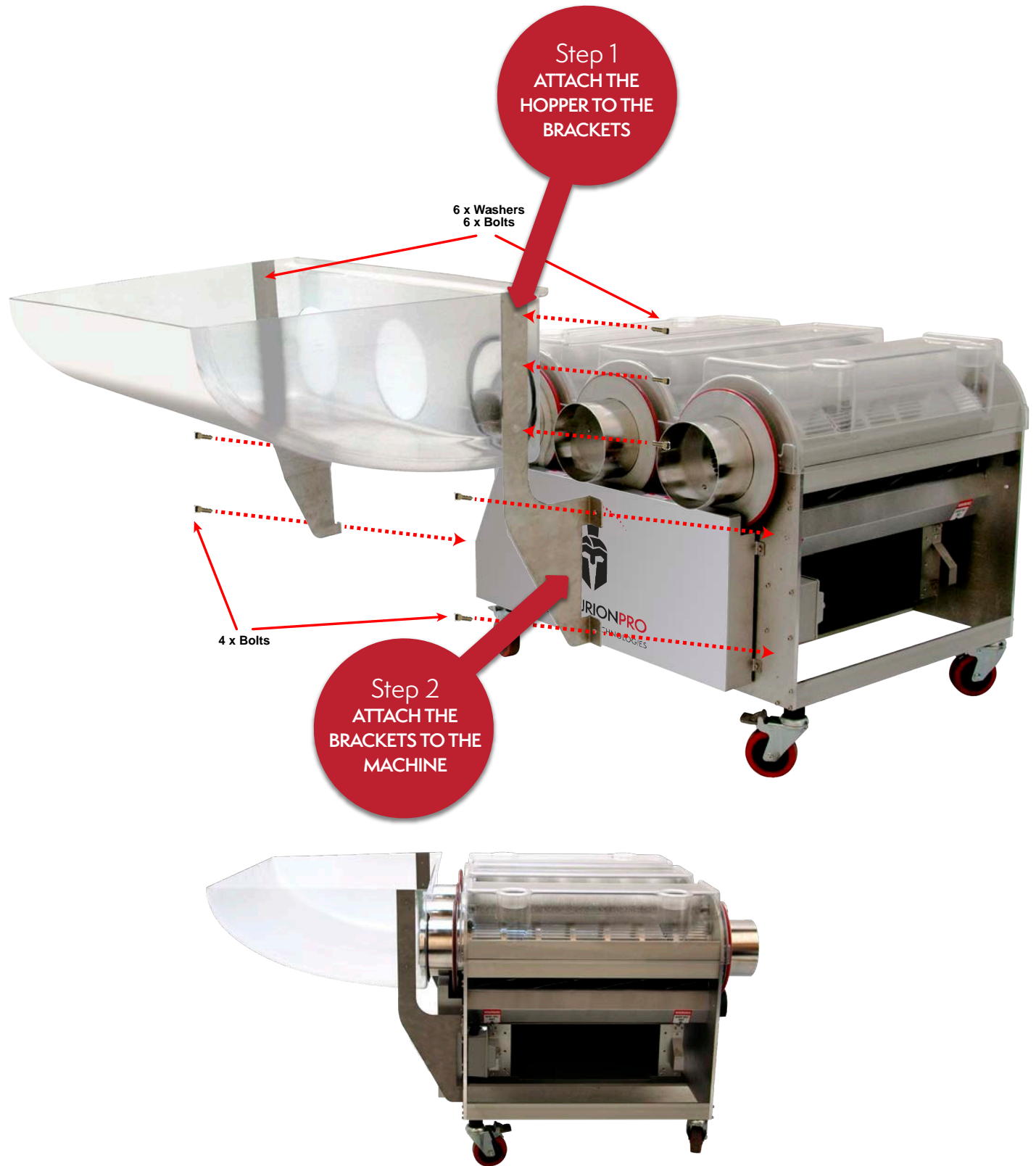

# CLOTH HOPPER ASSEMBLY

**Step 1**  
ASSEMBLE THE  
FRAME

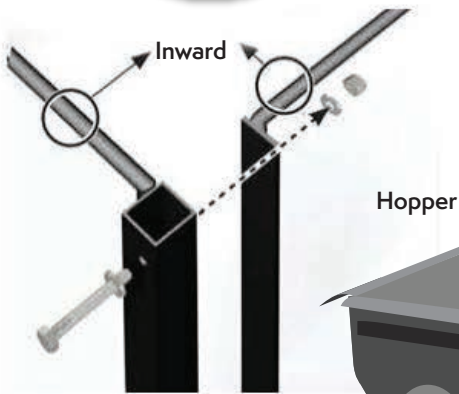

**Step 2**  
SECURE THE  
HOPPER BAG TO  
THE FRAME

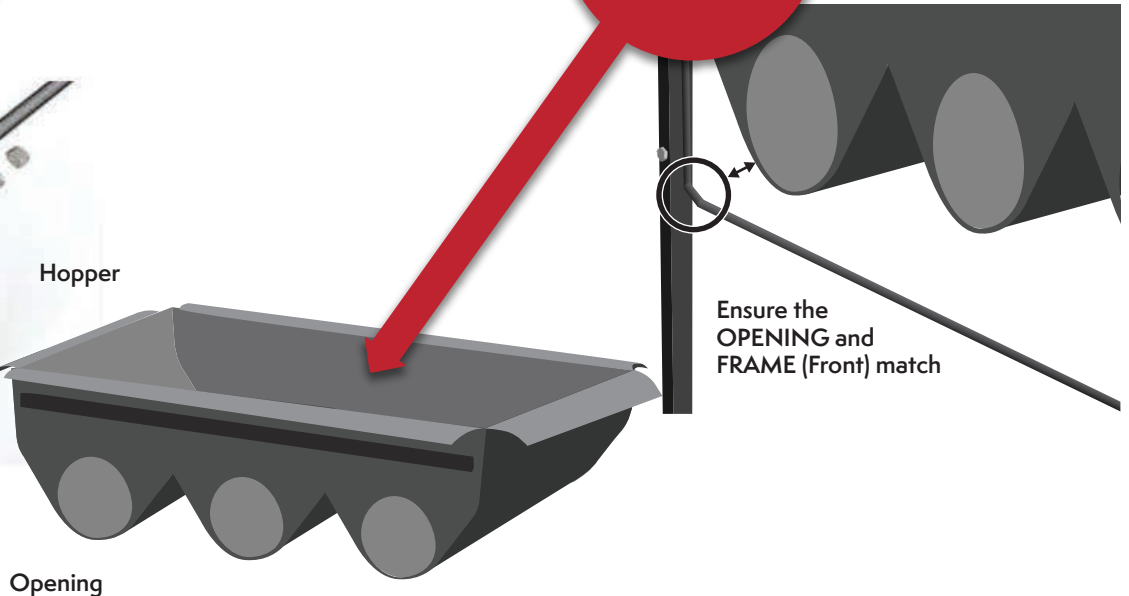

Ensure the RODS are facing  
inward. Secure with 1/4"  
BOLTS, WASHERS &  
LOCKING NUTS

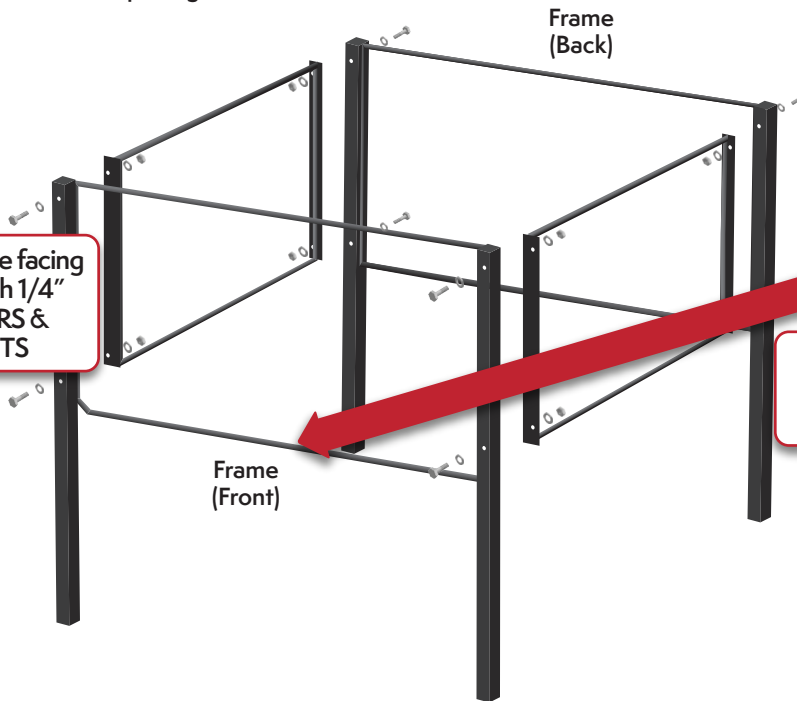

**Step 3**  
CONNECT THE  
HOPPER TO THE  
MACHINE

Ensure the Frame and OPENING  
match the CENTURION PRO  
machine exactly

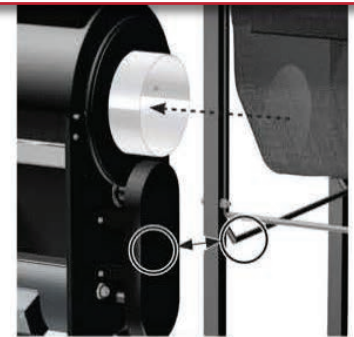

# BLADE REMOVAL

For optimal performance and life, the BLADES and the MAGNET BARS must be removed and cleaned every few hours of operation.

**IMPORTANT NOTE:** Your bed bar blade has been factory set to cut perfectly. Please do not alter the settings of your machine. You might notice slight contact between your rotating cutting reel and the flat bed bar blade - this is normal.



# CLEANING THE 3.0

For optimal performance and life, the components must be cleaned every 2 to 3 days of use.

Clean with pressure-washer at 1500-2000 PSI. Hot water, fan spray setting.

Run the machine for 15 minutes after washing. Allowing components to dry.

Clean the length of the Cutting Reel and Shroud of all debris.

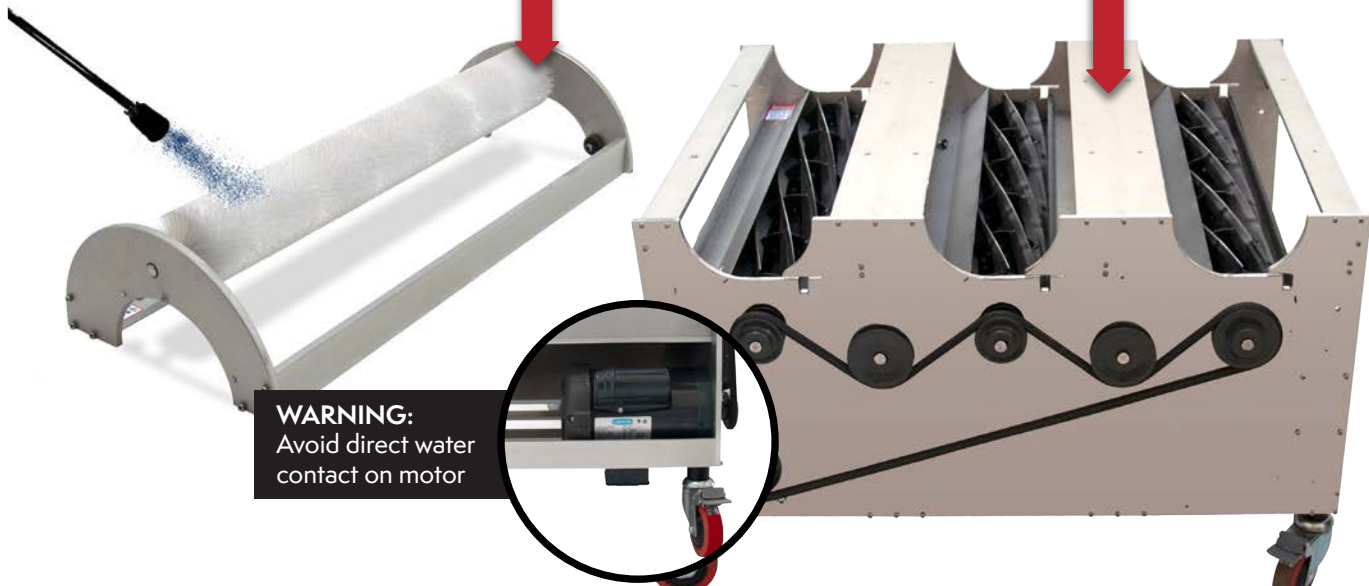

# LEAF COLLECTOR CLEANING

For Optimal performance and life, the LEAF COLLECTOR components must be cleaned every 30 days of use.

## INSTRUCTIONS:

Clean with pressure-washing at 1500 - 2000 PSI, Hot Water, Fan Spray Setting. Run LEAF COLLECTOR for 15 minutes after washing, allowing components to dry. Avoid water contact on **bearings and motor**.

Step 1  
REMOVE THE  
COVER AND  
IMPELLER FROM  
THE LEAF  
COLLECTOR



When removing the impeller, use a pulling tool only!! DO NOT FORCE THE IMPELLER OUT.



Step 2  
PRESSURE WASH  
THE IMPELLER AND  
THE INTERIOR OF  
THE LEAF  
COLLECTOR



Only use pulling tool when removing the blower impeller for cleaning. Clean blower every 30-40 days of use.



# MACHINE MAINTENANCE

The 3.0 is a precision machine. It is essential that it is operated and maintained with this in mind. The machine has been adjusted and tested by the manufacturer prior to shipping to ensure optimal performance. However, it is important to inspect the machine at initial start-up and after each use to ensure that no damage or plant material build-up has occurred and that the blades spin freely.

In addition, it is highly recommended to clean the machine at the end of every use. This ensures that the blades are kept lubricated and that resin does not build-up and affect performance. This is especially important if the machine has been stored for an extended period of time.

Each machine comes equipped with a standard electropolish stainless steel tumbler. This tumbler can be easily cleaned by pressure washing. If this component is a little sticky or has not been cleaned in a while, let it soak in warm soapy water and wipe it down. CenturionPro also offers an optional non-stick Quantanium coated tumbler for further processing efficiency and to further preserve the precious trichomes on your flower. This tumbler is best washed in warm, soapy water or, in extreme cases, can be cleaned with a mixture of 3 TBSP vinegar, 1 TBSP liquid dish detergent and 1 cup of water. Remember - keeping a clean tumbler will ensure the machine always runs smoothly!



# QUANTANIUM COATED NON-STICK TUMBLER

## WHAT IS QUANTANIUM?

Quantanium is a multi-coat non-stick coating that incorporates a unique mix of titanium particles. These particles are blended into the coating that stands up to almost anything and makes the tumbler resistant to scratching. The outstanding release is provided by silicone, not PTFE. All of our Quantanium coated tumblers are made without PTFE/PFOA.



## WHY DO WE USE QUANTANIUM?

### *Higher Potency Harvest*

The non-stick properties of the Quantanium tumbler prevents precious trichomes from adhering the tumbler surface without the need for sprays. This results in the end product having a better visual appearance while maintaining its strong natural aroma and flavors. Overall, this results in a better-quality end product as the natural properties are preserved during the harvesting and trimming processes.

### *Save Time = Save Money*

Another benefit of the Quantanium tumbler is that it speeds up the harvesting process since no downtime is required to stop and clean the tumblers throughout the day. A simple whip down with a cloth and warm water will remove the small amount of residue that may be present.

## HOW TO CLEAN THE QUANTANIUM TUMBLER

When cleaning the Quantanium tumbler, we recommend that you **DO NOT** pressure wash it. This will cause the coating to flake and come off. Treat the tumbler the same way you would treat a non-stick pan at home by letting it soak in warm, soapy water. After letting it soak, rinse the tumbler and then wipe it with a soft, clean cloth.

In extreme cases, residue can be removed by a thorough cleaning with 3 TBSP of vinegar, 1 TBSP liquid dish detergent and 1 cup of water. Apply with sponge or plastic scrubbing pad, then completely rinse with warm water.

DO NOT use automotive degreasers.

While the Quantanium surface is designed to stand up to rough treatment, non-stick surfaces last longer if you are careful not to rub or touch them with metal surfaces or sharp objects. Remember that sensible care of your Quantanium tumbler will ensure it lasts for many years.

# !! IMPORTANT !!

## WARRANTY

YOU MUST REGISTER YOUR TRIMMER WITHIN 30 DAYS OF YOUR PURCHASE

You have just made a smart decision by purchasing the best trimmer in the world. Failure to register your machine within 30 days of purchase will void your 10 year warranty. Protect your investment. This process will only take 3 minutes to complete.

TO REGISTER GO TO:

[cprosolutions.com/warranty](http://cprosolutions.com/warranty)

### WARRANTY TERMS & CONDITIONS

CenturionPro Solutions (the manufacturer) will repair or replace, without charge, any parts proven defective in material or workmanship for a period of 10 years on the Trimming Machine and 3 years on the Leaf Collector.

The warranty period will begin on the date the machine(s) is purchased by the initial purchaser. Product or component warranty defects can be remedied at any authorized service dealer, or directly at the manufacturer. Any service work performed, and deemed valid due to a defective part, will be free of charge. CenturionPro Solutions reserves the right to use any manufacturer-approved replacement part for the warranty repair.

If warranty repair is required, please contact the manufacturer at 1-855-535-0558 or [techsupport@cprosolutions.com](mailto:techsupport@cprosolutions.com) and provide the following information:

1. Model and serial number
2. Proof of purchase date
3. A copy of the original Warranty Registration Card or Online Submission
4. Details of the defect or problem (include photos and videos)

The machine or defective part then must be returned to the manufacturer for analysis or replacement at the cost of the owner. Parts deemed to be covered under the warranty will be provided for free excluding shipping costs.

Do not return the machine to the place of purchase for repair or warranty claims, unless you have been authorized by CenturionPro Solutions to do so. The place of purchase can only sell replacement parts and will not repair any warranty issues, unless it is noted as an authorized repair dealer and has been authorized to work on your machine.

You may be denied warranty coverage if your machine has failed due to any of the following:

- Product abuse
- Product neglect
- Improper maintenance
- Improper electrical connection
- Normal wear
- Accidental damage
- Unapproved modifications

The manufacturer assumes no risk and shall be subject to no liability for damages or loss resulting from the specific use or application made of the product. In no event will the manufacturer be liable for any special, incidental or consequential damages (including loss of use, loss of profit and claims of third parties) however caused - whether by negligence of the manufacturer or otherwise. If you have any questions regarding your warranty rights and responsibilities, please contact the manufacturer.

CenturionPro trimming machines are intended for use on legal aromatic herbs and hops. Please check all municipal, provincial/ state and federal laws and regulations before using these machines. CenturionPro Solutions does not promote or condone the use of these products in any way that may be deemed illegal. Allow only persons who understand this disclaimer to operate the machines.





# FREQUENTLY ASKED QUESTIONS

## HOW EASY IS IT TO CLEAN?

Our machines can be taken apart and cleaned within 10-15 minutes. There are four screws to remove the top cover, pressure wash the machine and then you're good to go. Our Quantanium coating is similar to a Teflon pan you would have at home which is even easier to clean. Just submerge in warm water, let soak and then wipe with a soft cloth. We recommend to clean every 4-6 hours of use, but it depends on your strain. We know the importance of down time during a harvest so we wanted to make this process extremely quick and easy.

## WHAT IS THE MAINTENANCE LIKE?

We have 15 video tutorials on our website with how to fully service your machine. These step by step videos make it very easy to do everything that will be necessary to maintaining your machine. All parts can be ordered right through the website and will be delivered to you within days.

## DO YOUR MACHINES TRIM WET OR DRY?

All CenturionPro trimming machines now come all inclusive with both wet and dry tumblers. You have a wet tumbler for wet trimming and a dry tumbler for dry trimming. This is a major benefit because you can purchase one machine and still have the capability to trim wet or dry flowers. Our dry tumblers have a smaller cutting surface than the wet. If you were to run dry product through a wet tumbler, you would have excess loss of flowers. Keeping the yield high is the biggest advantage to having a specific tumbler for both methods of harvesting, wet or dry.

## ARE YOUR MACHINES BUILT TO AN INDUSTRIAL STANDARD?

We do not compromise quality for cost savings. All CenturionPro Solutions machines are composed of the highest quality materials available in North America and each machine is put through a comprehensive quality control inspection. We only use brand name components in the build out of our machines which enables us to have the comfort in giving you a 10 year warranty. With proper maintenance these machines will last you well over a decade.

## WHAT IS THE OPTIMAL ROOM TEMPERATURE TO TRIM?

Use your CenturionPro machine in 50-60 °F (10- 15 °C) room to get the best performance. Cooler temperatures prevent excessive sticking to machine components.

## MY MACHINE IS NOT WORKING LIKE IT DID WHEN IT WAS NEW, WHY?

Make sure to fully clean the machine and blades. If the machine is clean, the blade is adjusted properly and the leaf collector has full suction, then your machine should trim exactly like it was new.

## THE PRODUCT IS NOT MOVING THROUGH THE TUMBLER, WHY?

You need to consistently feed the tumbler so it is about 50%-60% full at all times. If the product won't pass through, try taking the plastic top cover off and you should instantly see it begin exiting the tumbler. You can also prop the back wheels up a bit to increase the angle the machine is on. Some strains are heavier and will need more of an angle to exit.

## WHY IS MY PRODUCT STICKING TO THE INSIDE OF THE TUMBLER?

If you find that product is sticking to the inside of the tumbler, first clean the tumbler. When you reassemble it, make sure the top brush bristles are poking through 1/4" into the tumbler.

## HOW MUCH PRODUCT SHOULD BE IN THE TUMBLER AT ONE TIME?

The tumbler should be 50-60% full when trimming.

# ADDITIONAL ASSISTANCE

You are about to enjoy the experience of CenturionPro Solution's automated trimming machine.

For critical information on assembly, cleaning, care, maintenance and how to operate your machine correctly, please review this manual and check out our video tutorials, which are posted on our website for your ease and convenience.

Go to [www.cprosolutions.com/video-tutorials](http://www.cprosolutions.com/video-tutorials) for our video tutorials.

These tutorials provide how-to assistance on the following aspects of machine maintenance:

If for some reason you can't find an answer to your question online or in your manual, please do not

- **Straightening the Tumbler/Drum**
- **Skirt Assembly**
- **Removing and Replacing The Belt**
- **Replacing The Motor**
- **Blade Removal and Cleaning**
- **Complete Unit Assembly**
- **Replacing the Bearings**
- **Bucking Your Product**
- **Trimmer Cleaning and Maintenance**
- **Replacing The Tumbler/Drum Ring**
- **Sharpening The Blade**
- **Cleaning The Blower**
- **Adjusting The Blade**
- **Packing The Bearings**
- **Replacing The Pulleys**

hesitate to contact us.

**We are open Monday through Friday from 9AM to 5PM PST.**

**Phone: 1-855-535-0558**

**Filling out the "Contact Us" form on the website, is another sure way to get in touch.**

## 3.0 AND LEAF COLLECTOR SPECIFICATIONS

### 3.0 TRIMMER

<b>Input Voltage</b>	13 Amp - 110V NA 8 Amp - 220V EU/AUS
<b>Dimensions</b>	39" L x 33" W x 25" H
<b>Weight</b>	180 lbs
<b>Reels</b>	3
<b>Blades Per Reel</b>	8 (x3)
<b>Cuts Per Minute</b>	140,000
<b>Tumbler Diameter</b>	6.5" (x3)
<b>Number of Tumblers</b>	3
<b>Human Trimmer Replacement</b>	75 people
<b>Processing Capacity</b>	Dry: 60-70 lbs/hr, Wet: 300-350 lbs/hr

### 3.0 LEAF COLLECTOR

<b>Input Voltage</b>	34Amp - 220V NA
<b>Dimensions</b>	27" L x 27" W x 27" H
<b>Weight</b>	189 lbs
<b>Horsepower</b>	6 hp
<b>Airflow Capacity</b>	5,000 CFM

# TRIMMING DRY? HERE ARE SOME IMPORTANT TIPS!

Thank you for purchasing your DRY tumbler Centurion machine. Below is some helpful information and tips which will ensure that you produce the best possible product and results when using the DRY trimmer:

Begin by hanging the entire plant, leaving the leaf on. Starting with 30% humidity at 60-65 degrees Fahrenheit for 24 hours, raising the humidity to 50-60% for another five to six days. Next, carefully cut all your flowers off the main stocks of the plant, leaving only flowers and leaves in tact. Then, depending on the density of the flowers, it should be ready to run through the machine.

The buds should be about 80-90% dry, which allow the fan leaf and sugar leaf to remain somewhat PLIABLE/BENDY, in a soft and flexible state. If the larger leaf is too dry and brittle (which makes it more difficult for the machine to pull this stiffer leaf through the slots of the drum, preventing a clean, sharp cut) raise the humidity up to 75% for about half a day to a full day. This, remarkably, softens up the unwanted leaf while returning almost no additional moisture to the main body of the buds.

It is CRITICAL for the unwanted leaves to be soft and bendy for this machine to preform a clean perfect cut. We also recommend using a humidifier or a water bottle with a misting nozzle to re-introduce a small amount of moisture to the unwanted leaves before running the flowers through the machine.

\*\*\*The leaves MUST be SOFT and PLIABLE for the dry trimmer to be EFFECTIVE.

\*\*\*Please note that this method will allow virtually no additional moisture back to the inner bud/flower. The moisture will only soften up the outer leaves.

After running the buds through the machine the chances are they are ready to bag up!

All that might be necessary is a quick test after the bag has been sealed by opening it back up to air them out a bit to achieve the perfect moisture content (curing process).

You may prefer to run the machine with the plastic cover off, and diverter almost open (this varies depending on the density of the strain). Please note the machine operates best when the tumbler is 40-50% full.

A huge bonus to the DRY trimming method is that the machine will require almost no periodic cleaning, as the Quantanium non-stick drum and blade will not gum up and therefore not reduce performance.

The main advantage of DRY trimming is said to be better preservation of all the strong natural aromas and flavours after the harvesting process is complete.

Months of work can be ruined in a few hours at the end so please be patient and take your time with the harvesting and curing process.

# TRIM BOTH WET AND DRY

*All CenturionPro Trimming Machines Now Come All Inclusive with BOTH WET and DRY tumblers!!!*

## WHY NOT USE A DUAL-PURPOSE STANDARD TUMBLER TO TRIM BOTH WET AND DRY FLOWERS?

Yes, a "dual-purpose standard tumbler" will harvest both wet and dry flower. But....You will not receive the same level of efficiency as using a tumbler designed specifically for a particular wet or dry trimming application.

The dual-purpose standard tumbler will not trim as fast or as clean as a dedicated wet tumbler and will not be as delicate on your flowers as a true dedicated dry tumbler. This is why we will not promote "dual-purpose standard" tumblers and this is also why CenturionPro includes both a wet and a dry tumbler with each machine.



## CENTURIONPRO REGULAR WET TUMBLER

## CENTURIONPRO NARROW DRY TUMBLER

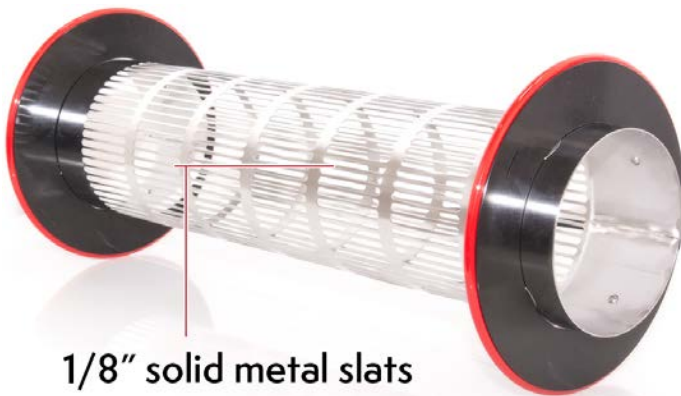

1/8" solid metal slats

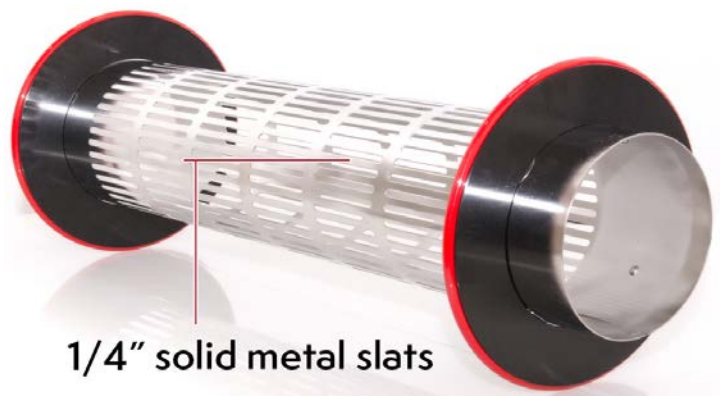

1/4" solid metal slats

The solid steel slats on our wet tumblers are 1/8" in width compared to 1/4" on tumblers offered by our competitors. Having a thinner slat means less metal material and more open area, resulting in an overall increase in access to the blades by 50% when compared to the 1/4" wide standard dual-purpose tumbler.

This increased cutting surface allows more of the flower to come in contact with the blades resulting in a tighter, closer, faster cut with just one pass. This negates the need for a second pass through a tumbler or placing machines "back-to-back". Less tumbler travel time means less agitation and better quality results!!

Another advantage to 1/8" wide slats is that the thinner slats have a smaller surface area for resin to build up on, therefore reducing resin loss and quickening tumbler clean up time.

**What does this mean???** You will have a higher potency product and less cleaning time when using our dedicated wet tumbler.

When fresh wet flowers are fully dried, they shrink to about 25%-30% in size of what they once were. They become brittle, fragile and more susceptible to damage.

For this reason, a Dry tumbler is needed when harvesting dry flowers because the cutting surface area is greatly reduced on the dry tumbler. The 1/4" wide steel slats means more metal material is present and there is less open area, thereby protecting the smaller fragile flowers from being overexposed to the blades of the machine. This will result in less trichome loss and a higher yield as more of your flowers will stay intact during the harvesting process.

You will not get this level of protection when using a "dual-purpose standard tumbler" to trim both wet and dry flowers.

# TROUBLESHOOTING

## 1) There is a high-speed ticking sound coming from the blades

This is normal. The ticking sounds are the blades making slight contact. If the machine is producing a louder than usual ticking/banging sound, then turn off the machine and inspect the blades. Ensure your blades are properly adjusted by following our video tutorial “Adjusting the Bed Bar Blade”

## 2) My product is not exiting out of the tumbler

The tumbler should always be 50%-60% full. You should be feeding the tumbler every 30-45 seconds, this will ensure that new product entering the machine will help push out product that is trimmed. You can also increase the downward slope of the machine. To do this place a piece of cardboard underneath the input side wheels. You may also remove the plastic lid to help increase output.

## 3) My leaf collector is not turning on

Ensure the correct voltage is being supplied as per your manual and never use an extension cord longer than 25 ft. Also, test your electrical current to make sure it is producing power. If it is, then your leaf collector’s electrical box may need to be replaced.

## 4) My tumbler is spinning slower than usual or is not spinning

You will need to take a link (or two) out of the belt. Use a pair of needle nose pliers to help you with this. When putting your tightened belt back on your machine it might be a little difficult. Use the video tutorial “Removing and Replacing the Belt” to help you with this. Once the belt is tightened properly, the tumbler speed will resume back to normal. Ensure that the tumbler is placed correctly in the grooves and there is no lubricant on the Tumbler O Rings.

## 5) The leaf collector suction seems weak

Ensure that nothing is blocking the inlet or outlet on the leaf collector. Try cleaning your bags as this will keep the suction performance high. Build up that occurs in the leaf collector around the impeller can cause the suction to become weak as well. Unplug the leaf collector and follow cleaning instructions.

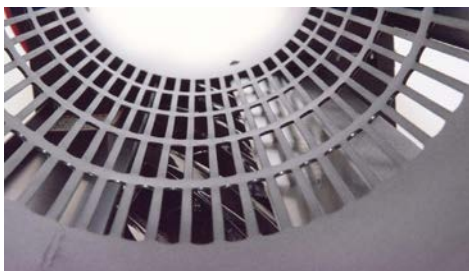

# TROUBLESHOOTING

## 6) The product is not coming out trimmed

If you are trimming dry and encountering this issue, please refer to our “Dry Trimming Tips” located on our website. The key with dry trimming is to ensure your leaves are bendy and pliable, therefore are able to be slipped through the slots on the tumbler to be trimmed by the blades.

*There are 3 things that determine the quality of the cut:*

a. First, ensure that your machine is clean. Clean the Bed Bar Blade (flat blade), top and underneath every 3-4 hours of use. The Reel Blade (rotary blade) should be cleaned every 6-8 hours of use. Think of the blades as a pair of scissors, if the blades are not clean the machine will not be able to do its job

b. Secondly, ensure that the Bed Bar Blade is set close to the Reel Blade. The space between the two blades should be the same thickness as a single sheet of newspaper - essentially, they should be skimming. Please refer to the video tutorial “Adjusting the Blade” on our website on how to set the Bed Bar Blade accurately. Again, think of the blades as a pair of scissors, if the blades are too far away from each other they will not trim your product.

c. Lastly, ensure the suction from the Leaf Collector is working correctly. Make sure there are no air-leaks. Keep in mind that long extension cords result in a decrease in performance of the leaf collector.

## 7) My machine motor is hot

Your machine may be overworking due to a voltage drop in your power supply. This can happen if you're using an extension cord that is too long or undersized. You can only use an extension cord with a maximum length of 25ft. Use a voltage tester to test your electrical current to ensure you have the correct voltage. The machine should be turned off for an hour, every 5 hours of use.

## 8) My leaf collector is making a loud banging noise

There is a bend in your impeller. You need to remove the impeller using ONLY a pulling tool. Refer to our manual for instructions on how to properly remove the impeller. Once the impeller is removed, you will need to purchase a new one.

## 9) The circuit breaker keeps tripping

This is caused by a cord that is too long or undersized. Your cord must be no more than 25ft long and the same gauge of thickness as the main cord. Also, ensure the machine is not sharing a circuit with other devices and the correct size breaker is present.



**CENTURION**PRO

ELITE TRIMMING TECHNOLOGIES



[cprosolutions.com](http://cprosolutions.com)



1 855 535 0558



[info@cprosolutions.com](mailto:info@cprosolutions.com)